



Wienerberger

Building Material Solutions

Wienerberger India Private Limited
88/4, Richmond road, Opp. HDFC Bank,
Bangalore-560025, Karnataka
Tel: +91 80 41491 682-7
Email: marketing@wienerberger.in

www.wienerberger.in



Aspect
Clay Ventilated Façades

Captivating Exteriors
Lasting for Generations

Classic Terracotta Façade



Aspect Clay Ventilated Façade tiles have set a new benchmark for the construction industry in India. Ingenuity and sophistication are the hall marks of Aspect - offering a selection of superior terracotta panels to fulfil your imaginative design aspirations.

A world class product

Aspect is brought to you by Wienerberger: The world's largest clay building material solutions provider, headquartered in Vienna, Austria, with a heritage of almost 200 years

One of the largest sellers of façade tiles in India since 2009

Providing a wide range of walling, cladding, façade and fencing solutions

Aspect Colours

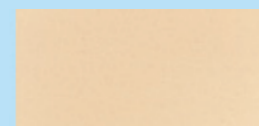

Apricot Beige

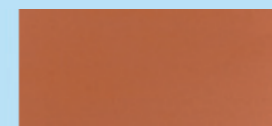

Natural Red

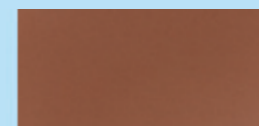

Red Brown

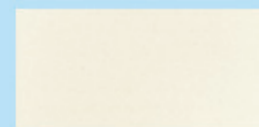

Pearl White

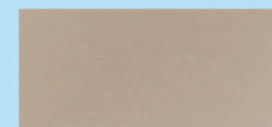

Platinum Grey

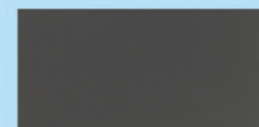

Volcano Grey

Detailing for Lower finish

Lower finish

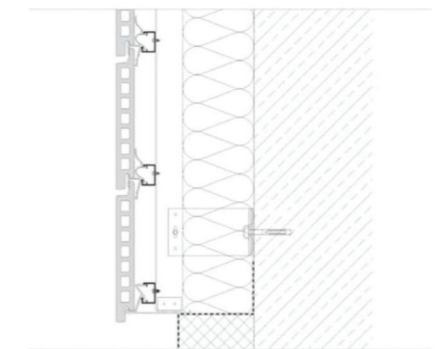
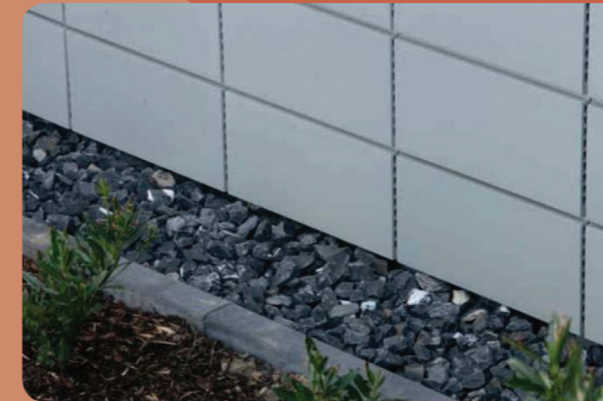

Lower finish with tiles



Connection wall/ceiling

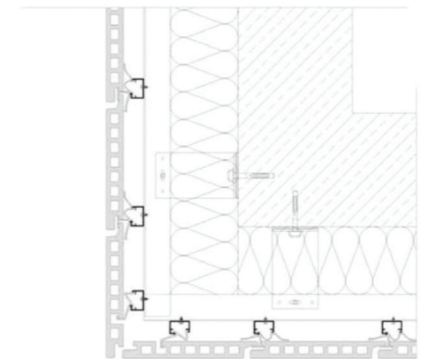



Contemporary looks, flexible design

Aspect façades conform to international quality standards and comfortably meet the varied demands of indigenous architectural design trends

Lend contemporary character and refined elegance

A choice selection of colours and range, to support design flexibility

Well-matched with steel, glass and wood

A cleverly designed run-off system to provide complete water and dust proof (rain screen)



Timeless Elegance

Aspect façade tiles are of natural, environment-friendly material enhanced with:

- Superior finish, weather-resistant, fast colour - the ceramic colours remain intact even when exposed to rough weather
- High strength and tested safety makes Aspect façades suitable for homes, offices and public buildings
- Maintenance-free

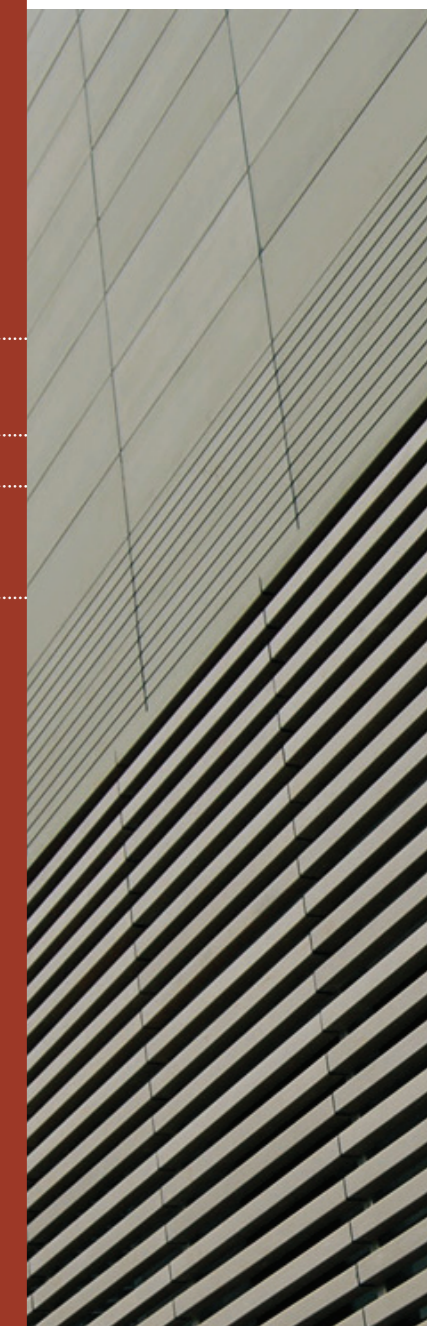

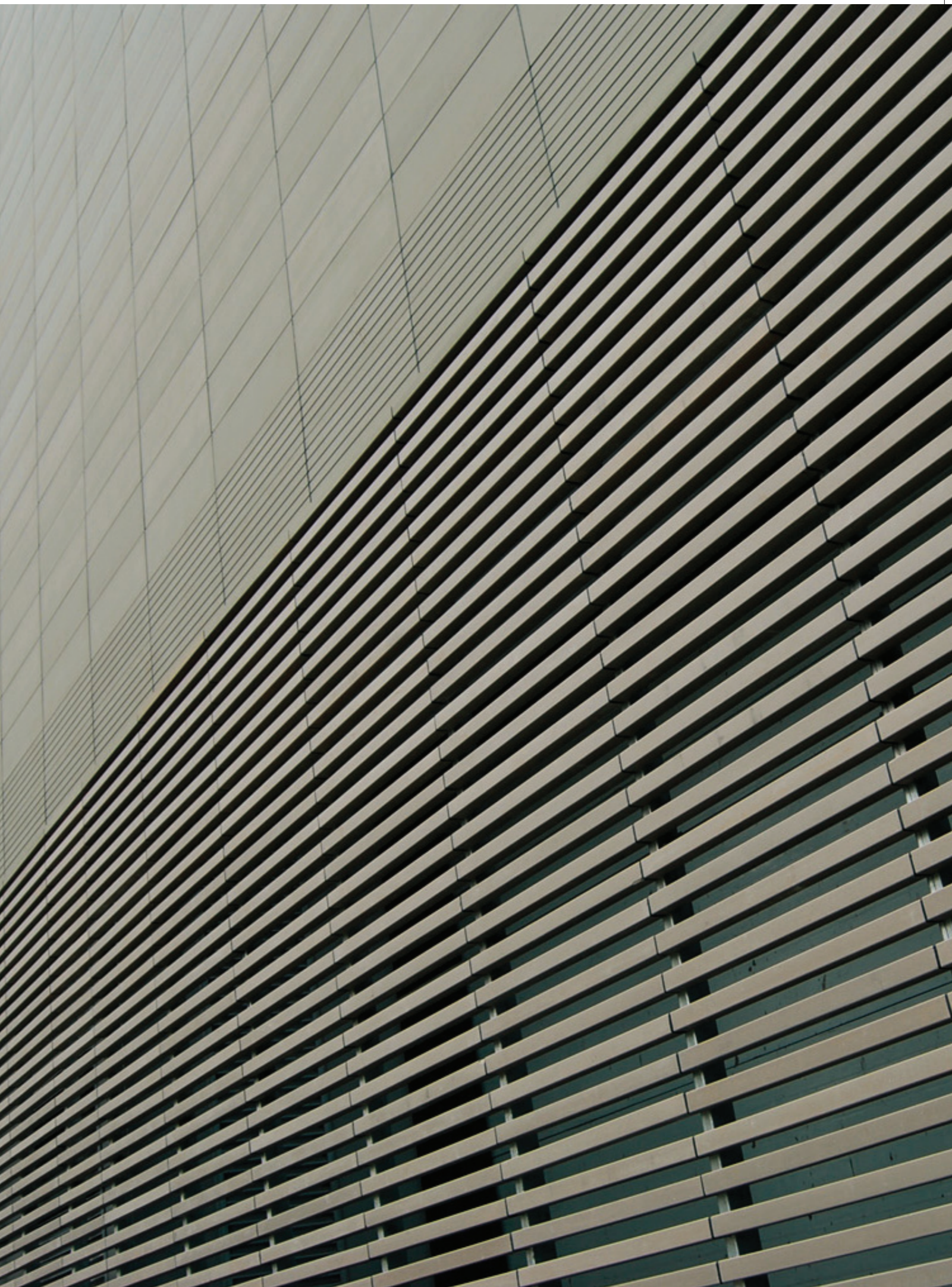
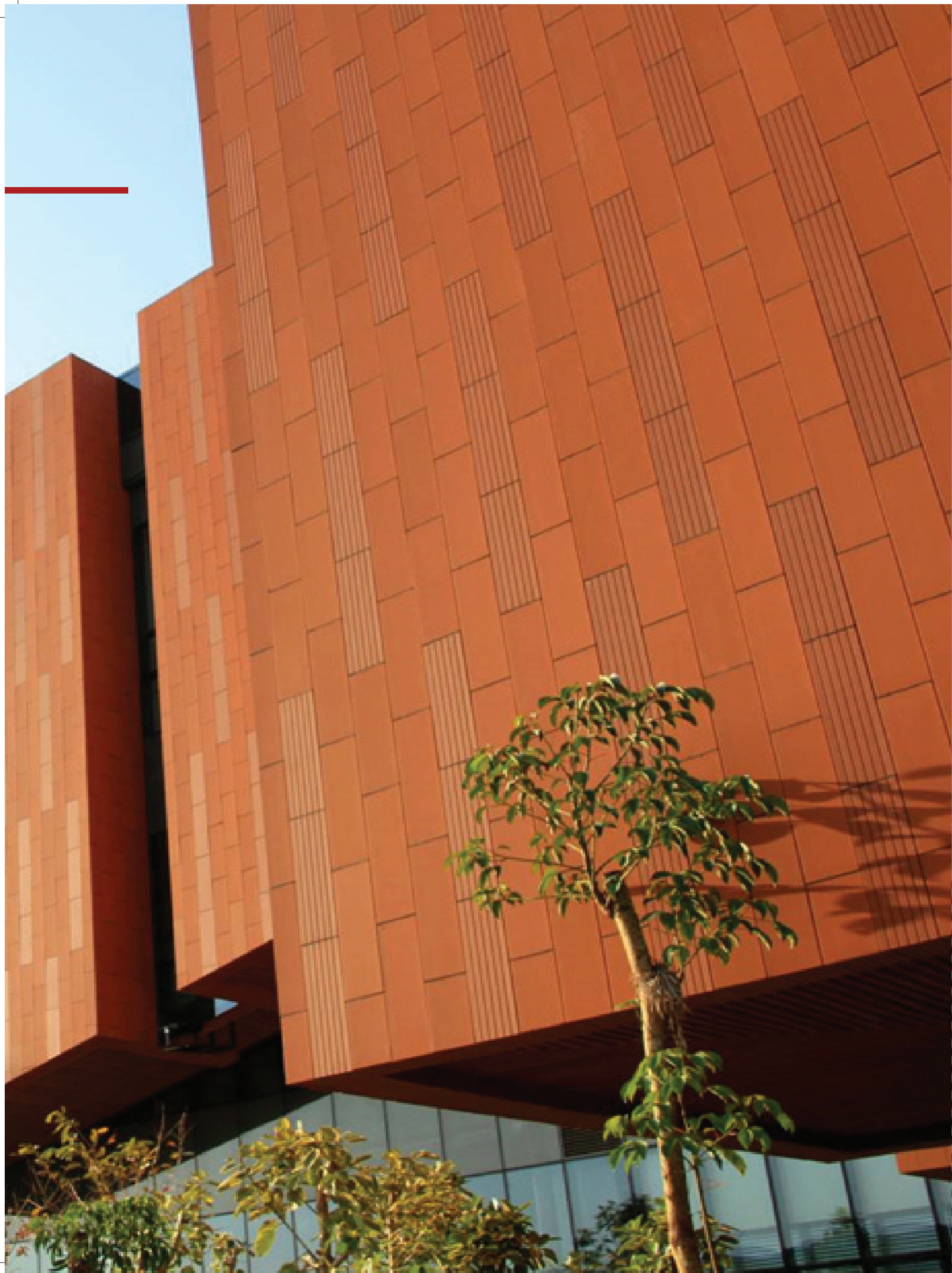

Barro

Creative element for an unique architecture
Can be used as a sun screen and visual screen or for aesthetics
Available in standard colours and also with engobes and glazes
Individual and special forms are possible

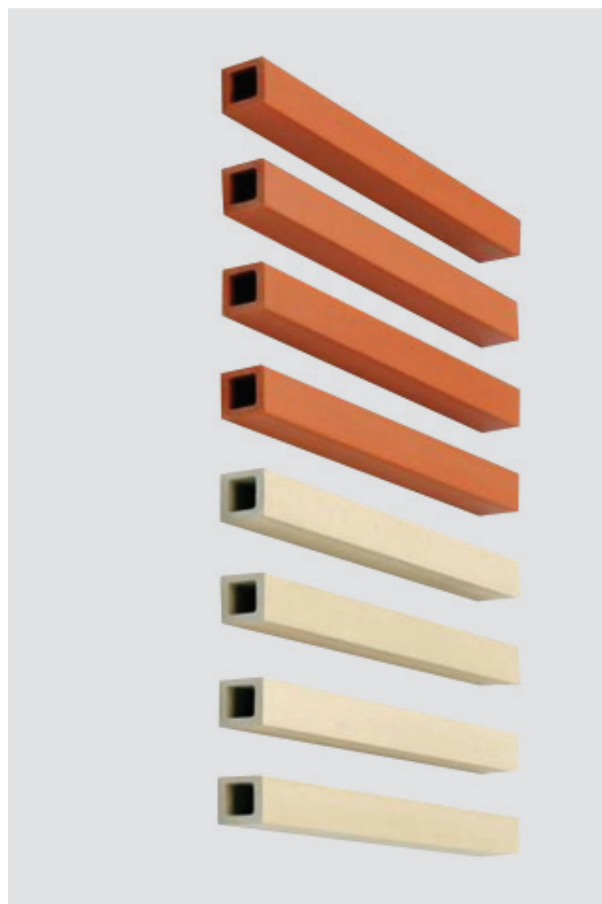
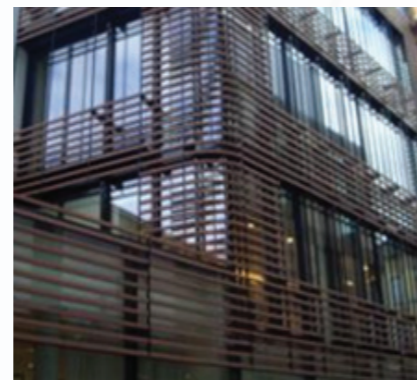

Aspect Technical Benefits

Sustainable building material, with multiple benefits:

- Long life of 50 to 60 years
- Provides thermal insulation and weather protection
- Provides improved sound insulation by approx. 9 dB
- Frost-proof, non-flammable (material class A1)
- Protection against impact, resistance to graffiti
- Virtually maintenance-free

Aspect Design Benefits

Available in a variety of formats (see product matrix)

- Diverse colours: besides standard colours, custom colours can be produced with engobe or glaze effect, grooved or structured
- Perfectly aligns with traditional construction materials, thus ideal for building renovation

Features of the Rear Ventilated Façade

Weather protection

- Preventing heat accumulation
- Moisture control
- Sound protection
- Thermal insulation
- Fire protection
- Ventilated Façade





▲ Eco-friendly manufacturing

The manufacture of the tiles begins with the extraction of natural resources whose collection area is re-cultivated according to ecological criteria. After careful processing of the clay, forming is carried out using a die in the so-called extrusion procedure. The drying phase follows the forming. The subsequent burning process (in a roller furnace designed specially for this purpose at 1080°C up to 1280°C) is performed under more efficient utilisation of energy, whose rejected heat is used for the drying process.

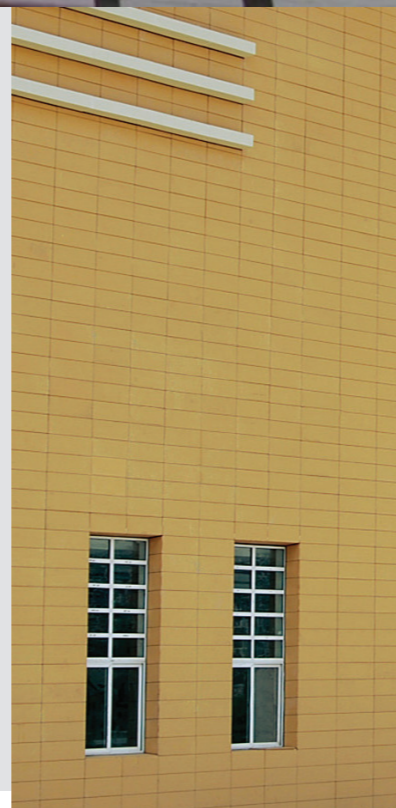

Aspect – General technical description

Façade system

The schematics in Figure 1 (vertical substructure) and 2 (horizontal substructure) display the structure and the elements of the rear ventilated Aspect façade systems.

Requirements

General

The applicability of Aspect façade systems is regulated in various country-specific technical approvals.

Specific requirements

Calculation of specific mass or density is performed in accordance with EN 10545-3. Aspect tiles meet the requirements for frost resistance according to EN 1304. In addition, tests according to EN 10545 are carried out regularly in the course of internal and external monitoring, eg. to determine:

- The mass, evenness and surface qualities
- Thermal shock resistance
- Water absorption
- Thermal expansion
- The bending strength & breaking load
- Moisture expansion
- Impact resistance
- Chemical resistance
- Resistance to staining

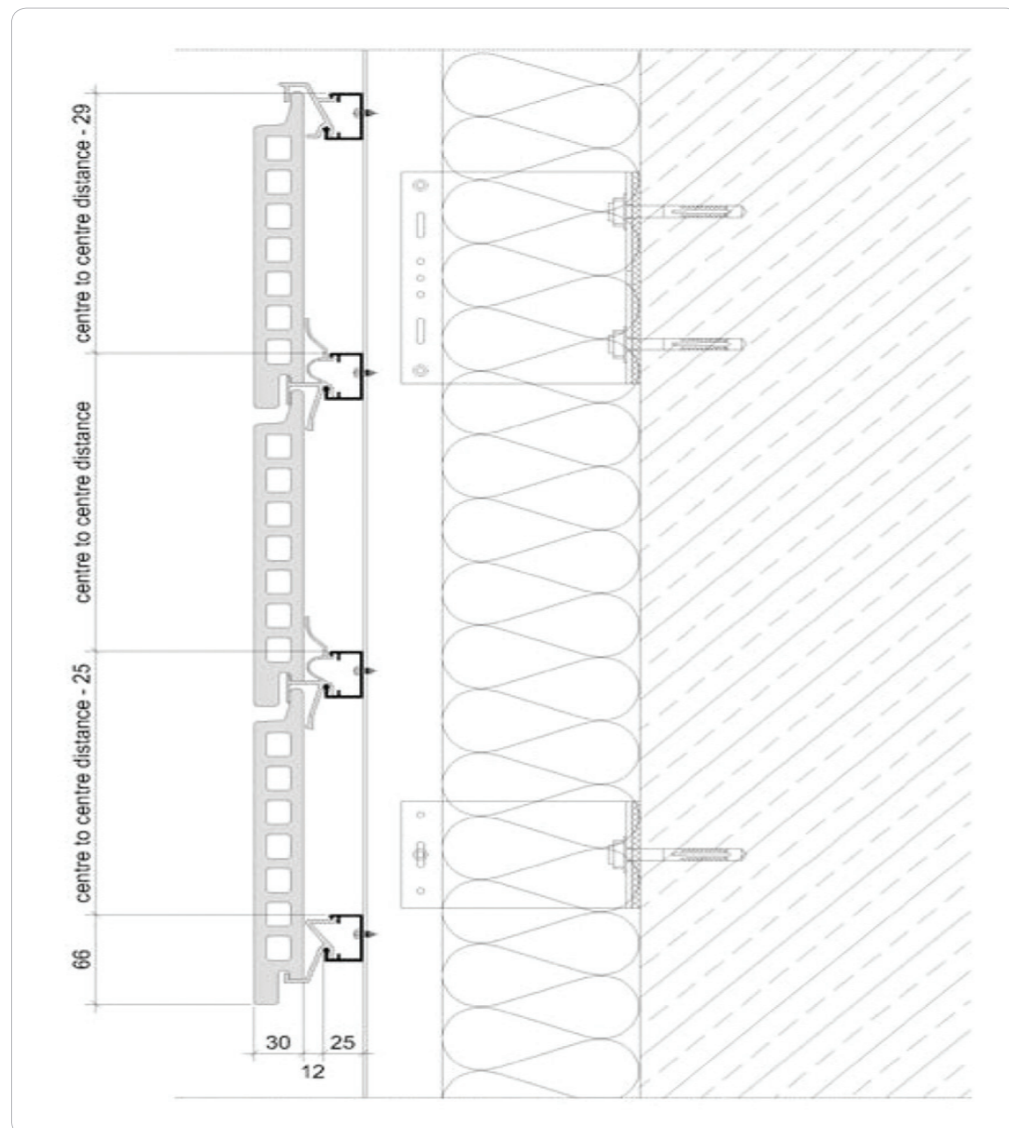

Installation dimensions (horizontal substructure):

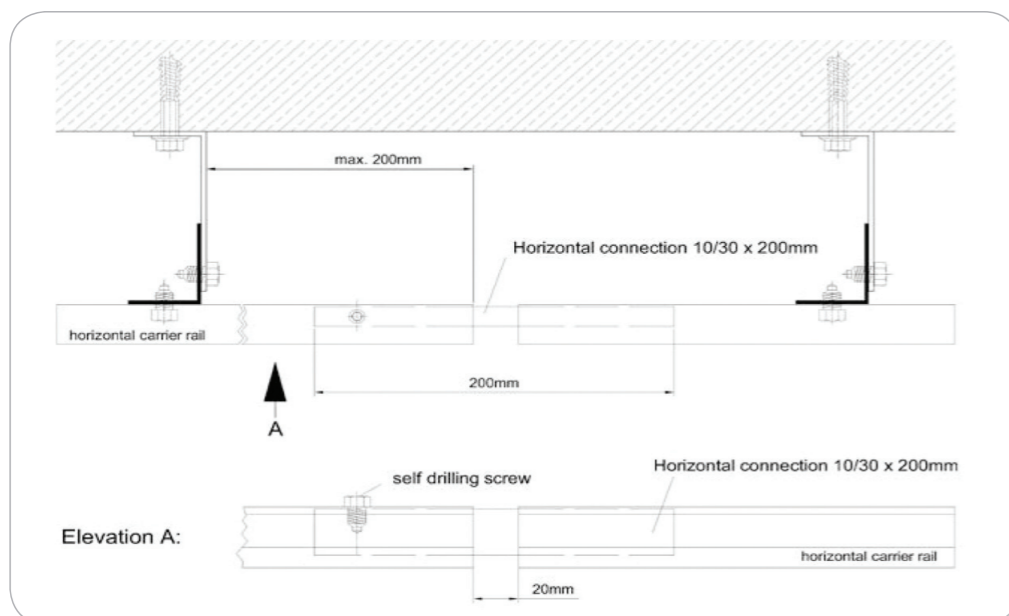

Joint connection between horizontal profiles:

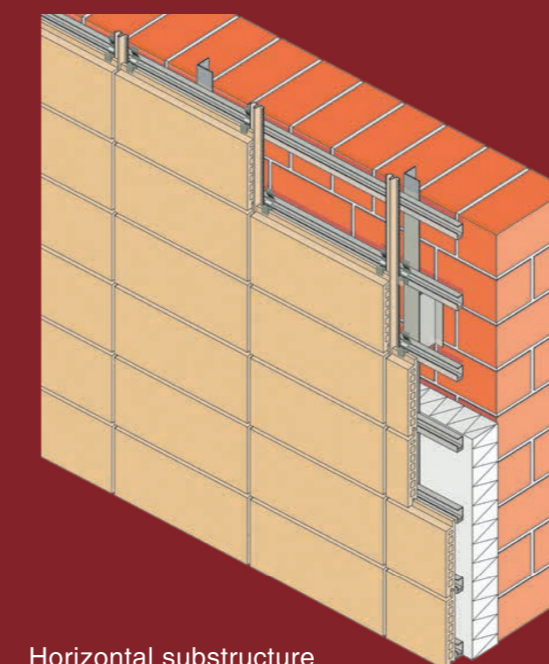

Horizontal substructure



Technical Data

Dimensions:	Length:	max. L = 1500 mm (tile height of 237.5 mm to 500 mm)	
	Height:	tile height ≤ 300 mm, tolerance ± 2.0 mm tile height > 300 mm, tolerance ± 2.25 mm	
	Thickness:	20&30 mm	
Form:	Wingity:	(out of plane)	±0.25 % of the diagonal
	Straightness:	(in the plane)	±0.25 % of the length/height
	Evenness:	(out of plane)	±0.25 % of the length
		(out of plane)	±0.70 % of the height
	Angularity:	(in the plane)	tile height ≤ 300 mm ± 1.0 mm
		(in the plane)	tile height > 300 mm ± 1.5 mm
Weight (dry):	42mm:	approx. 42 kg / m ² (= 35 mm thickness: approx. 59 kg/m ²)	
	20mm:	approx 29Kg / sq.m	
Body density:		≥ 2.0 g / cm ³	
Bending strength:		12–20 N/mm ²	
Water absorption:		≤ 9.0 % acc. to test reports of Güteschutz Ziegel e. V. between 3 and 8 %	
Frost resistance:		acc. to test reports of Güteschutz Ziegel e. V.	
External control and test reports:		IFBT GmbH – Institut für Fassaden- und Befestigungstechnik Leipzig Güteschutz Ziegel e. V.	

Accessories

Joint profiles

Aluminium joint profiles are available either for 8 mm or 4 mm wide vertical joints in a length of 3 m. They can be supplied in the colours RAL 1015 light ivory, RAL 7005 mouse grey, RAL 7015 slate grey and RAL 8004 copper brown.

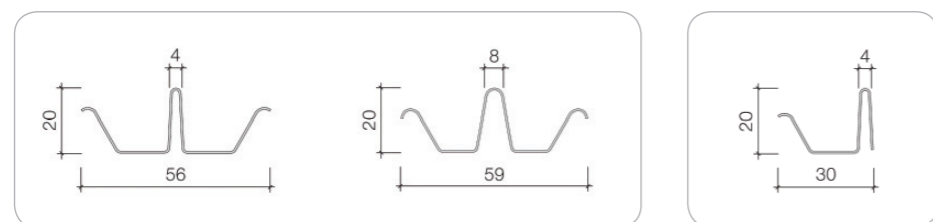

Joint abutment profile

Abutment joints are designed with a joint width of 4 mm.

Horizontal Substructure – Installation Dimensions

Tile length ≤ 1000 mm:
20 mm clamps

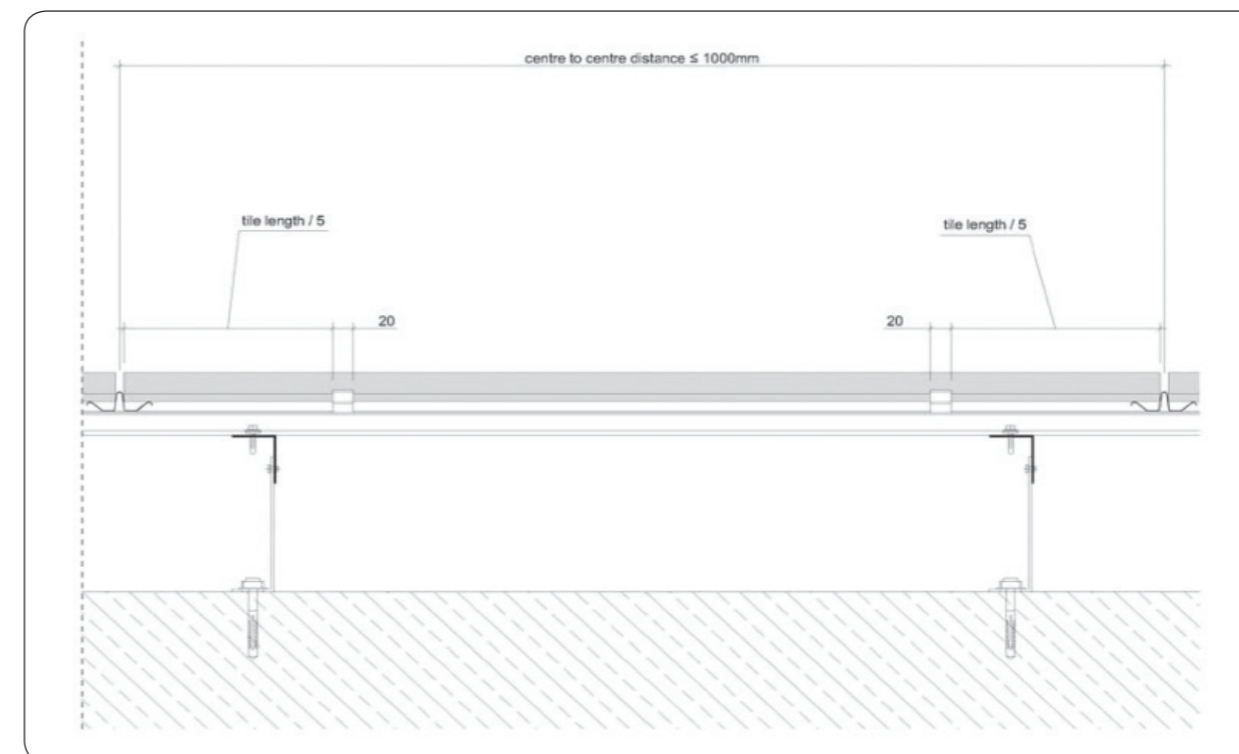

Horizontal Substructure – Accessories

Top Clamp

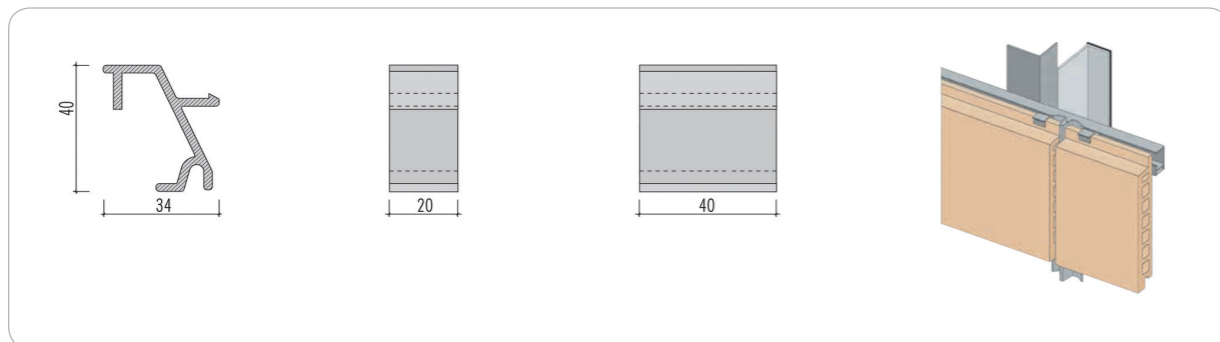

Bottom Clamp

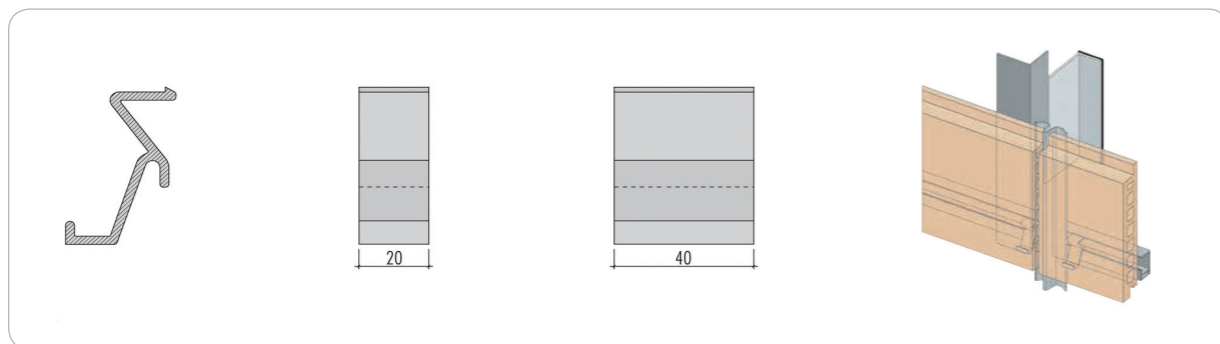

Horizontal Carrier Rails

Maximum span width:

Horizontal rail 25 x 35: 120 cm

Horizontal rail 25 x 45: 140 cm

Maximum protruding length:

Horizontal profile 25 x 35: 35 cm

Horizontal profile 25 x 45: 35 cm

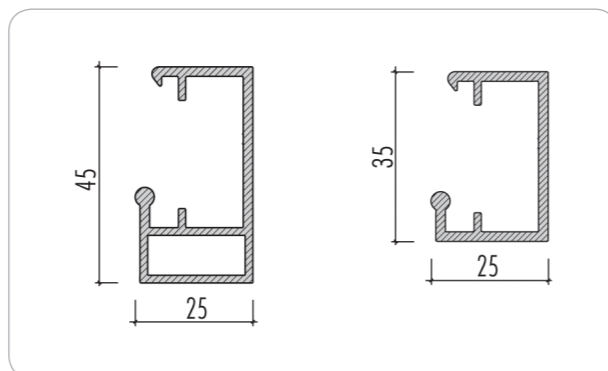

Corner profile

Aluminium corner profiles are blank depending on the request, anodised or coloured according to available RAL colours.

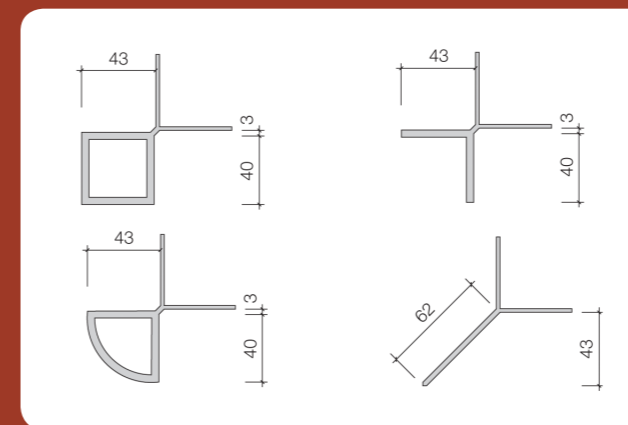

Spring profile

Spring profiles are to be provided for connections (e.g. building corners with a miter cut) where no joint profiles are possible. They ensure that the tiles are firmly pressed into the clips or clamps.

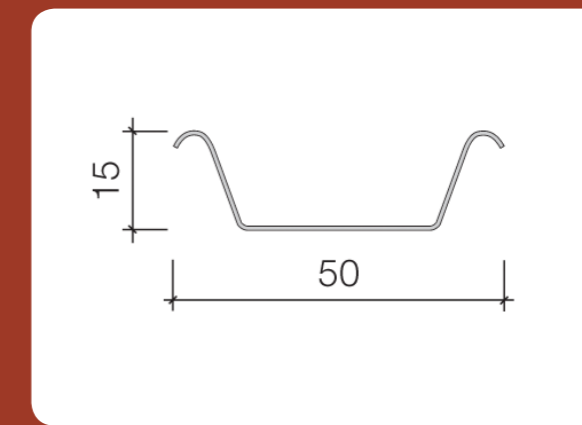

Tile exchange

Subsequent installation of tiles (horizontal + vertical UK):

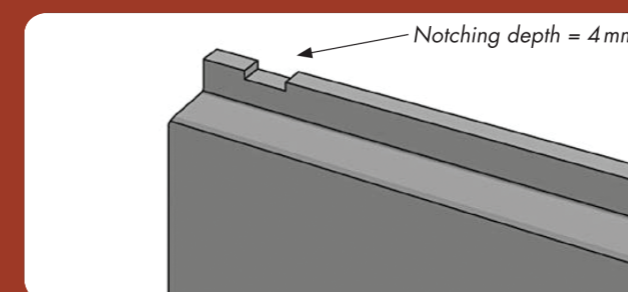

Shorten tile lip in the area of the clip

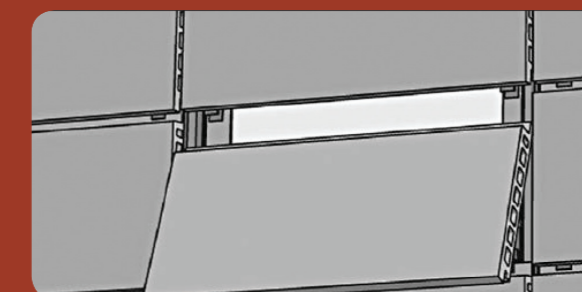

Install new tile

Vertical Substructure

Basic concept

The substructure consists of vertical T-profiles, anchored to the building with wall brackets. The Aspect tiles are to be fixed by aluminium clips in the vertical T-profiles. Joint profiles have to be placed in the vertical joints. This prevents lateral movement of the façade tiles and makes sure that the tiles sit securely in the clips. Also, water is prevented from penetrating the vertical joints.

Installation of Aspect tiles

First, the bottom clips have to be fixed, always two per Aspect tile, onto the T-profiles with blind rivets or screws. In the next step the tiles can be installed onto the clips. The fixation of the tiles is carried out by installing the middle clips onto the T-profile. This procedure has to be repeated for every row up to the top of the façade. The top row is to be fixed by a special top clip. The joint profiles have to be placed between the tiles as soon as the first tile row has been completed.

Substructure and insulation

For the vertical basic substructure aluminium wall brackets are anchored in statically required intervals on the building wall. Afterwards, thermal insulation is applied to the previously cleaned surface of the wall. The choice of insulation material in each individual case depends on the property and its particular requirements. The T-profiles are aligned with the consoles and fastened with approved fasteners such as rivets or screws.



Horizontal Substructure

The substructure consists of vertical L-profiles anchored to the building with wall brackets. Horizontal aluminium rails are installed on the basic substructure. The distance depends on the height of the tiles which are fastened to the horizontal rails with aluminium clamps. Joint profiles are arranged in the vertical joints. This prevents lateral movement of the façade tiles and makes sure that the tiles sit securely in the clamps. In addition, water is prevented from penetrating the vertical joints.



Substructure & insulation

For the vertical, basic substructure aluminium wall brackets are anchored in statically required intervals on the building wall. The arrangement of the basic substructure is independent of the height of the façade tiles. Afterwards, thermal insulation is applied to the previously cleaned surface of the wall. The choice of insulation material depends on the particular requirements of the property. Vertical L-profiles are aligned with the consoles and fastened with approved fasteners such as rivets or screws. The special horizontal Aspect support rails are fixed onto the vertical L-profiles.

Horizontal Substructure – Installation Instructions

Anchoring the wall brackets

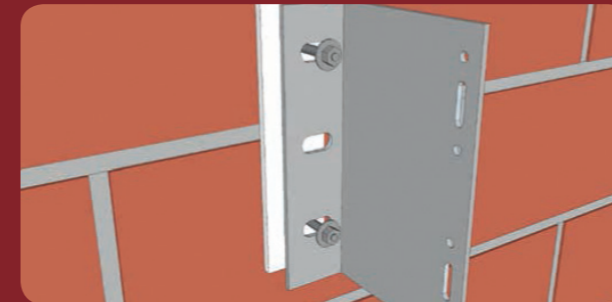

Installation of thermal insulation

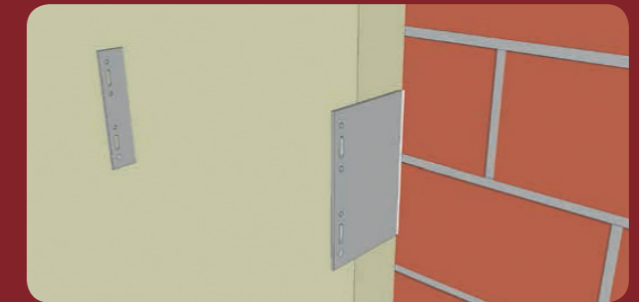

Securing angular support profiles to the wall consoles



Installation of the horizontal profiles

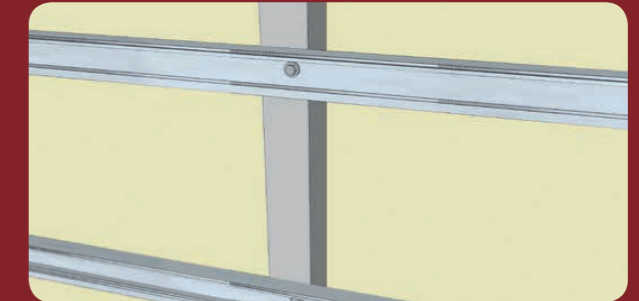

Installation of the first tile row with bottom clamps and fixing of joint profiles



Installation of middle tile rows with middle clamps



Installation of the top tile row

